

Dálet

D

ד

דָּלֶת

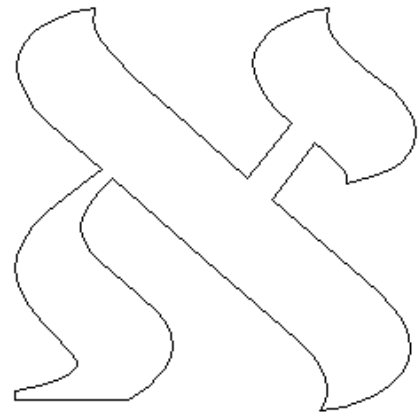

Alef

א

אָלֶף

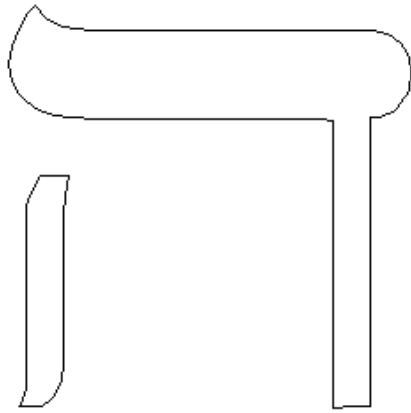

Hei

H

ה

הֵי

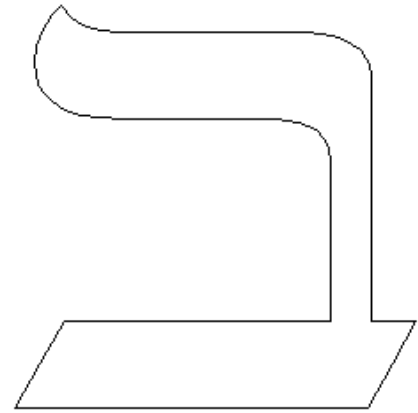

Bet, Vet

B,V

ב

בֵּית

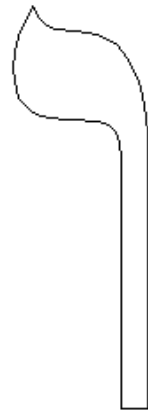

Vav

V

ו

וָו

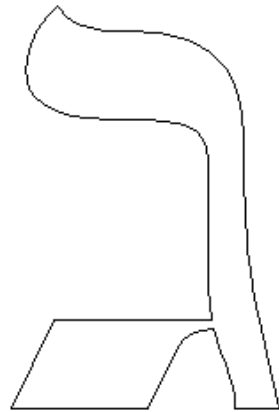

Guímel

G

ג

גִּימֵל



Yod

I,Y

י

יוד

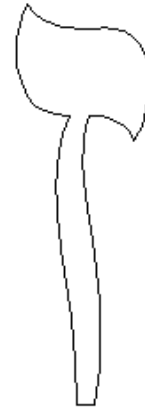

Zain

Z

ז

זין

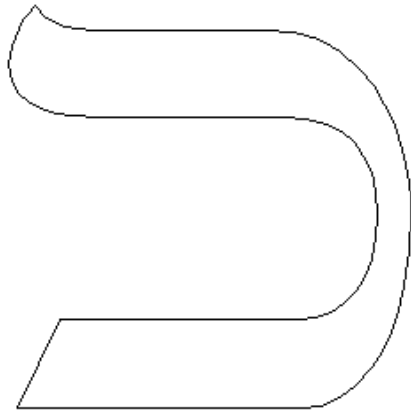

Kaf, Jaf

K,J

כ

קף

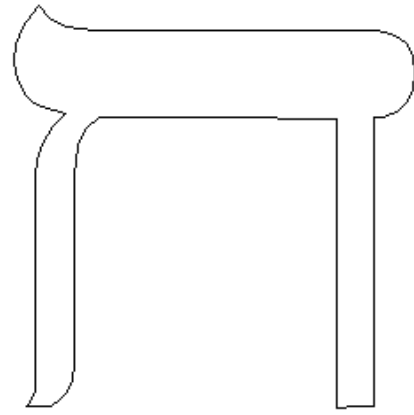

Tet

J

ח

חית

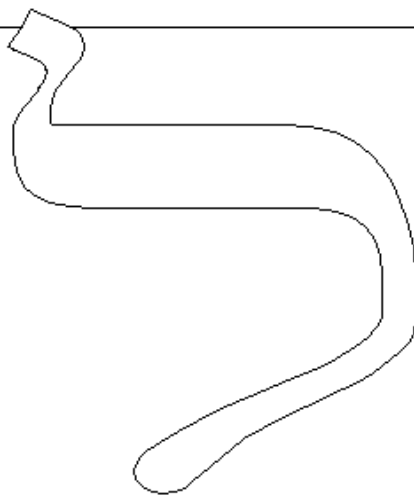

Lamed

L

ל

למד

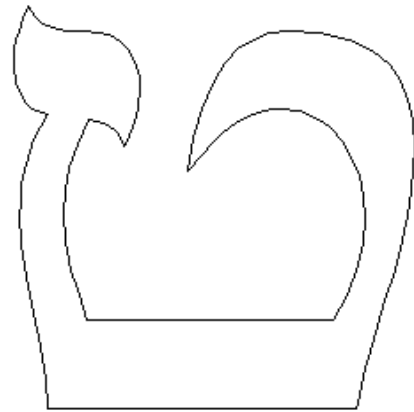

Tet

T

ט

טית

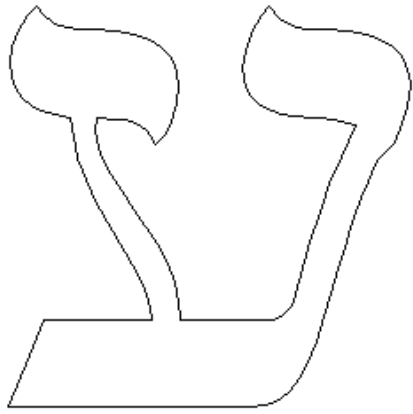

Ayin

ע

עין

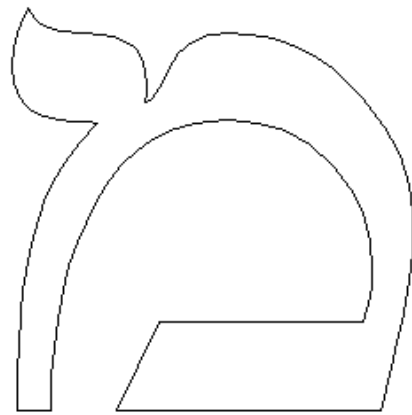

Mem

M

מ

מם

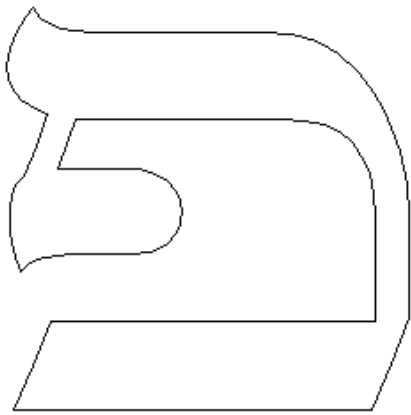

Fe, Pe

F,P

פ

פם

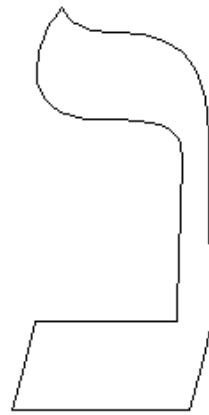

Nun

N

נ

נן

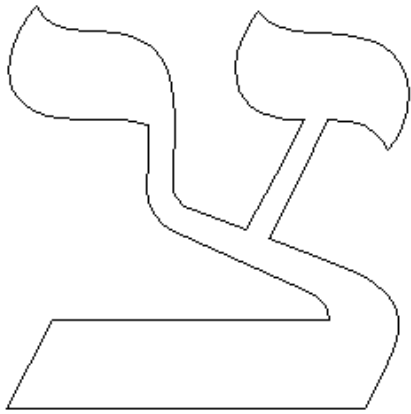

TSádi

Ts

צ

צדי

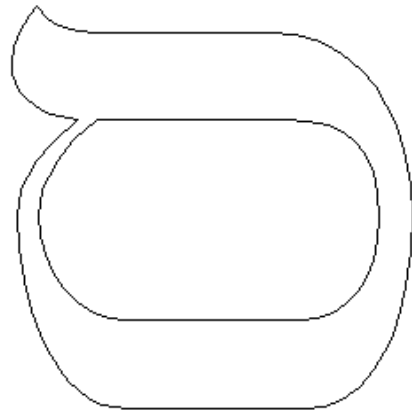

Sámej

S

ס

סם

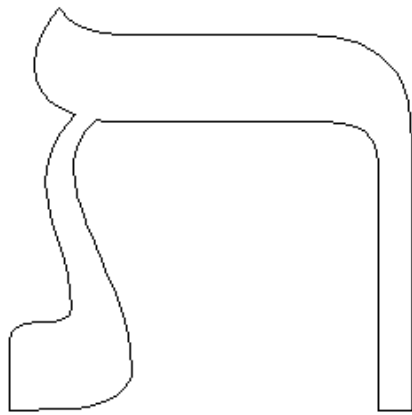

Táv

T

ט

טו

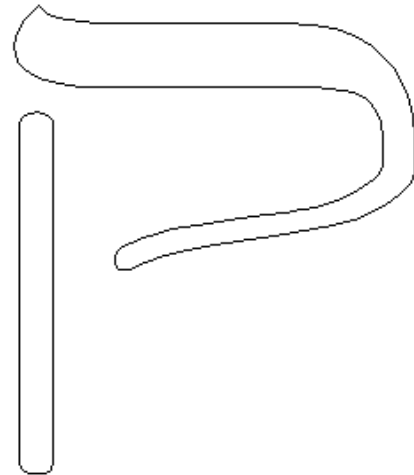

Kof

K,Q

כ

קוף

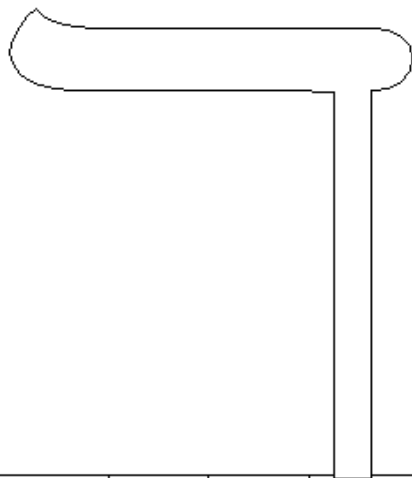

Kaf, Jaf

K,J

כ

כ = כ

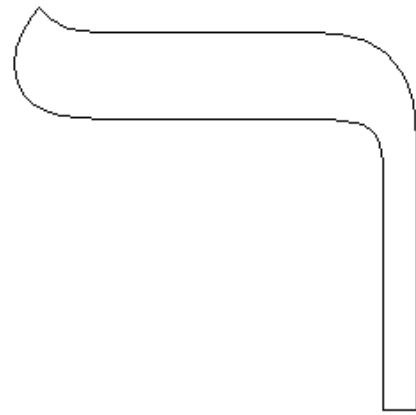

Reish

R

ר

ריש

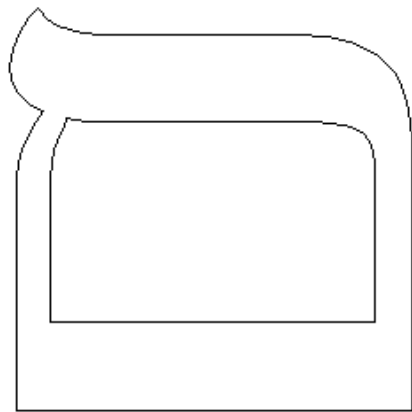

Mem

M

מ

מ = מ

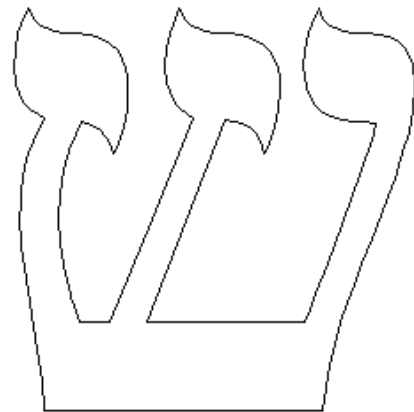

Sin, Shin

S,Sh

ש

שין

			
Pataj	A	-	פָּתַח

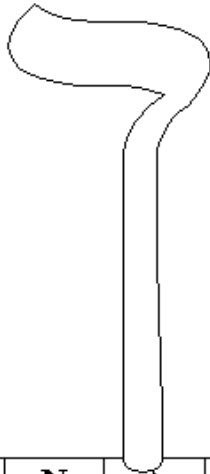
			
Nun	N		נ = ן

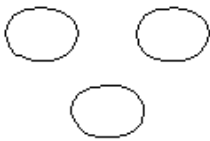
			
Segol	E	◌ֶ	סֶגוּל

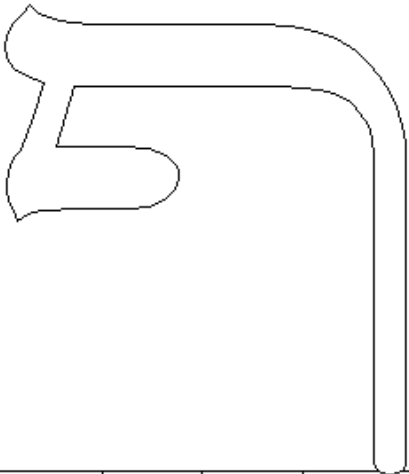
			
Fe, Pe	F,P	פּ	פּ = פֿ

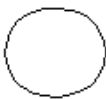
			
Jirik	I	◌ִ	חִירִיק

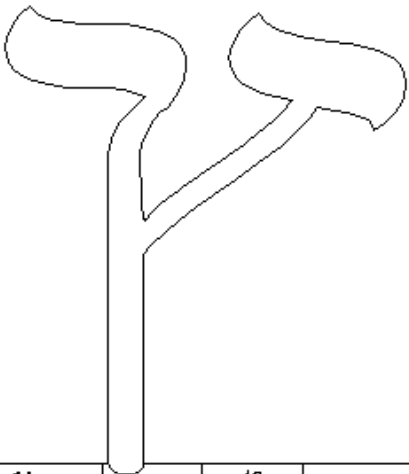
			
TSadi	Ts	צ	צ = ץ

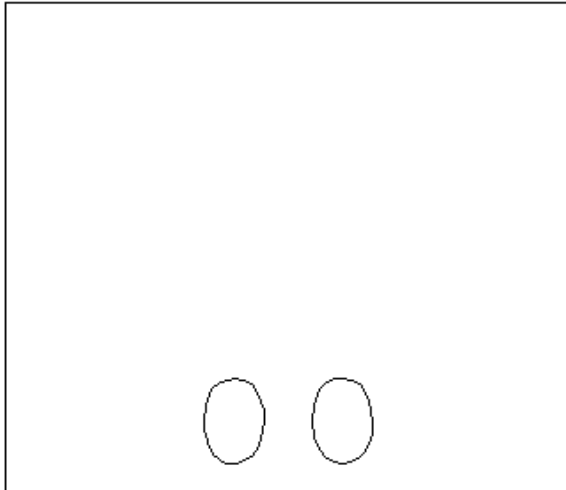

TSere	AE	..	צֵרֵי חֶסֶר
-------	----	----	-------------

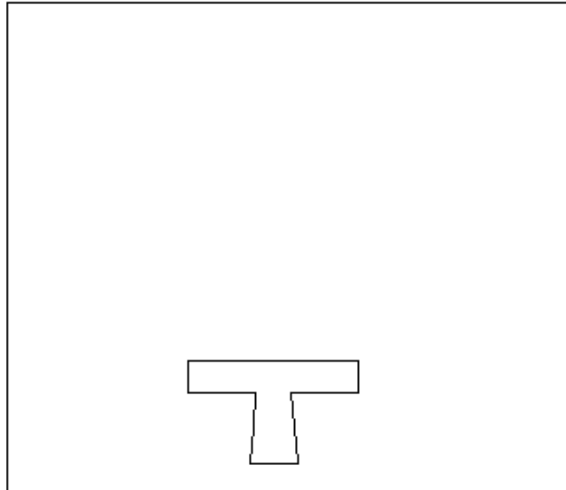

Kamats	O	.	קָמָץ קָטָן
--------	---	---	-------------

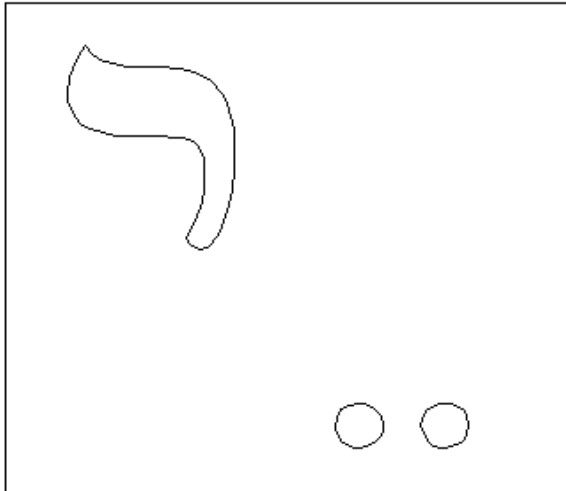

TSere	AE	..	צֵרֵי מְלֵא
-------	----	----	-------------

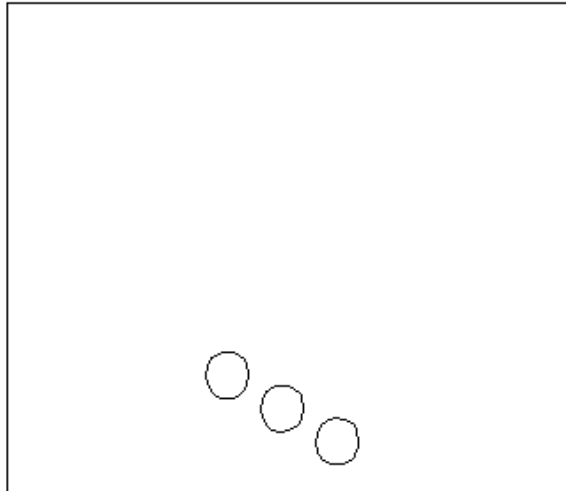

Kubuts	U	..	קִבּוּץ
--------	---	----	---------

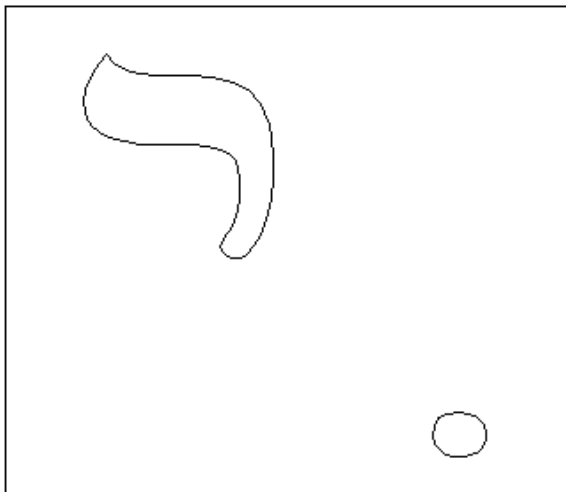

Jirik	I	.	חִירִיק מְלֵא
-------	---	---	---------------

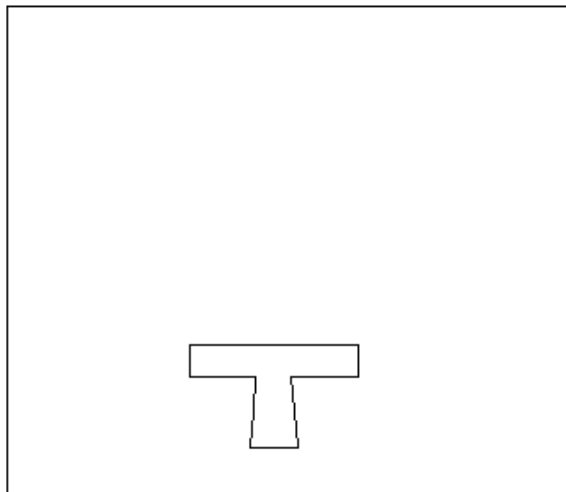

Kamats	A	.	קָמָץ גָּדוֹל
--------	---	---	---------------

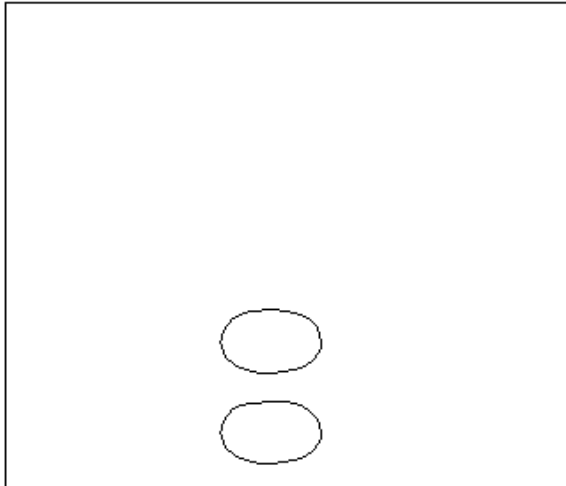

Sheva	,E	.	שְׁוָא
-------	----	---	--------

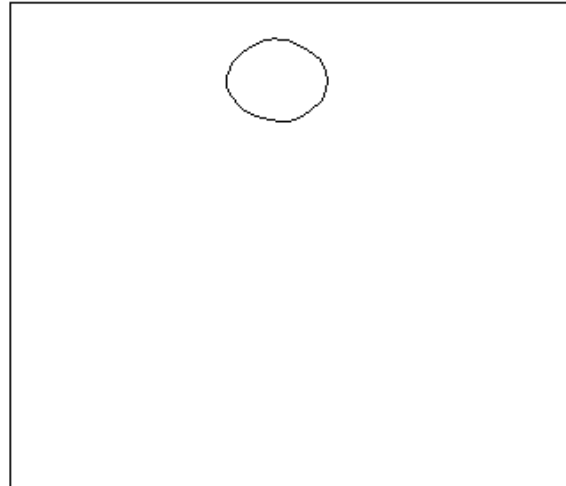

Jolam	O	.	חֹלָם קָסֵר
-------	---	---	-------------

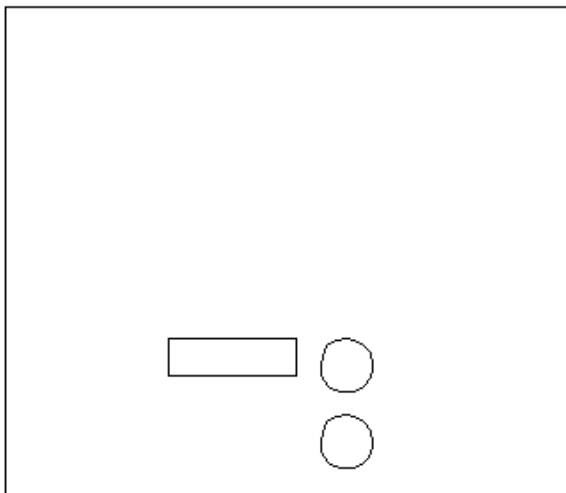

Jataf	A	.	חֶטֶף פָּתַח
-------	---	---	--------------

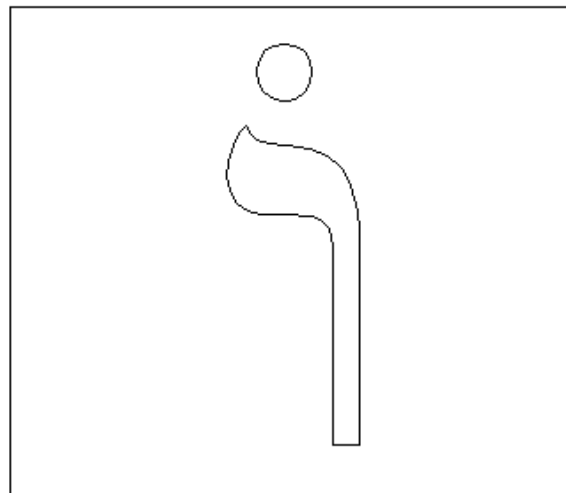

Jolam	O	ו	חֹלָם מְלֵא
-------	---	---	-------------

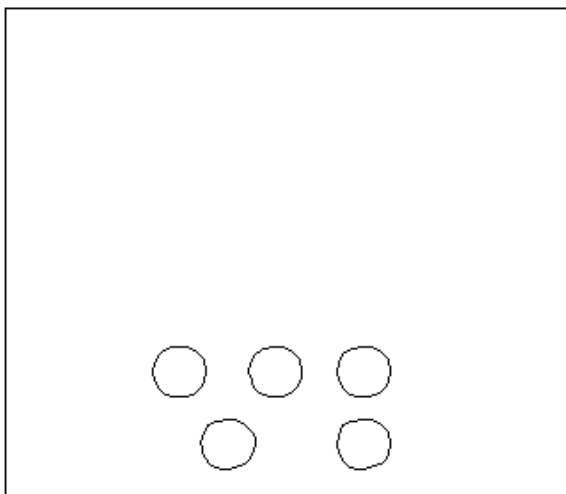

Jataf	E	..	חֶטֶף סְגוּל
-------	---	----	--------------

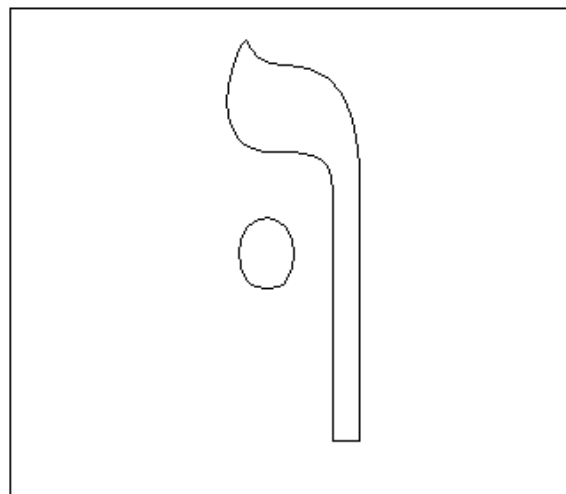

Shuruk	U	ו	שׁוּרֻק
--------	---	---	---------

LETRAS			
Alef		א	אָלֶף
Bet, Vet	<b>B,V</b>	ב	בֵּית
Guimel	<b>G</b>	ג	גִּימֵל
Dálet	<b>D</b>	ד	דָּלֶת
He	<b>H</b>	ה	הָא
Vav	<b>V</b>	ו	וָו
Záin	<b>Z</b>	ז	זַיִן
Jet	<b>J</b>	ח	חַיִת
Tet	<b>T</b>	ט	טִית
Yod	<b>I,Y</b>	י	יּוֹד
Kaf, Jaf	<b>K,J</b>	כ	כָּף
Lámed	<b>L</b>	ל	לָמֶד
Mem	<b>M</b>	מ	מֶם
Nun	<b>N</b>	נ	נוּן
Sámej	<b>S</b>	ס	סָמֶךְ
Ayin		ע	עַיִן
Fe, Pe	<b>F,P</b>	פ	פֶּא
Tsadi	<b>Ts</b>	צ	צָדִי
Kof	<b>K</b>	ק	קוֹף
Reish	<b>R</b>	ר	רֵישׁ
Sin, Shin	<b>S,Sh</b>	ש	שַׁיִן
Tav	<b>T</b>	ת	תָּו

LETRAS FINALES			
Kaf	<b>K</b>	ך	כ = כּ
Mem	<b>M</b>	ם	מ = מּ
Nun	<b>N</b>	ן	נ = נּ
Fe, Pe	<b>F,P</b>	ף	פ = פּ
Tsádi	<b>Ts</b>	ץ	צ = צּ
VOCALES			
Pataj	<b>A</b>	-	פֶּתַח
Segol	<b>E</b>	ֿ	סְגוּל
Jirik	<b>I</b>	.	חִירִיק
Kamats	<b>O</b>	ֿ	קָמָץ
Kubuts	<b>U</b>	ֿ	קִבּוּץ
Kamats	<b>A</b>	ֿ	קָמָץ
Tsere	<b>AE</b>	ֿ	צֵרִי
Tsere	<b>AE</b>	ֿ	צֵרִי
Jirik	<b>I</b>	ֿ	חִירִיק
Jolam	<b>O</b>	ֿ	חֹלָם
Jolam	<b>O</b>	וּ	חֹלָם
Shuruk	<b>U</b>	וּ	שׁוּרוּק
Sheva	<b>,E</b>	.	שְׁוָא
Jataf pataj	<b>A</b>	ֿ	חֲטָף
Jataf segol	<b>E</b>	ֿ	חֲטָף
Jataf kamats	<b>O</b>	ֿ	חֲטָף